

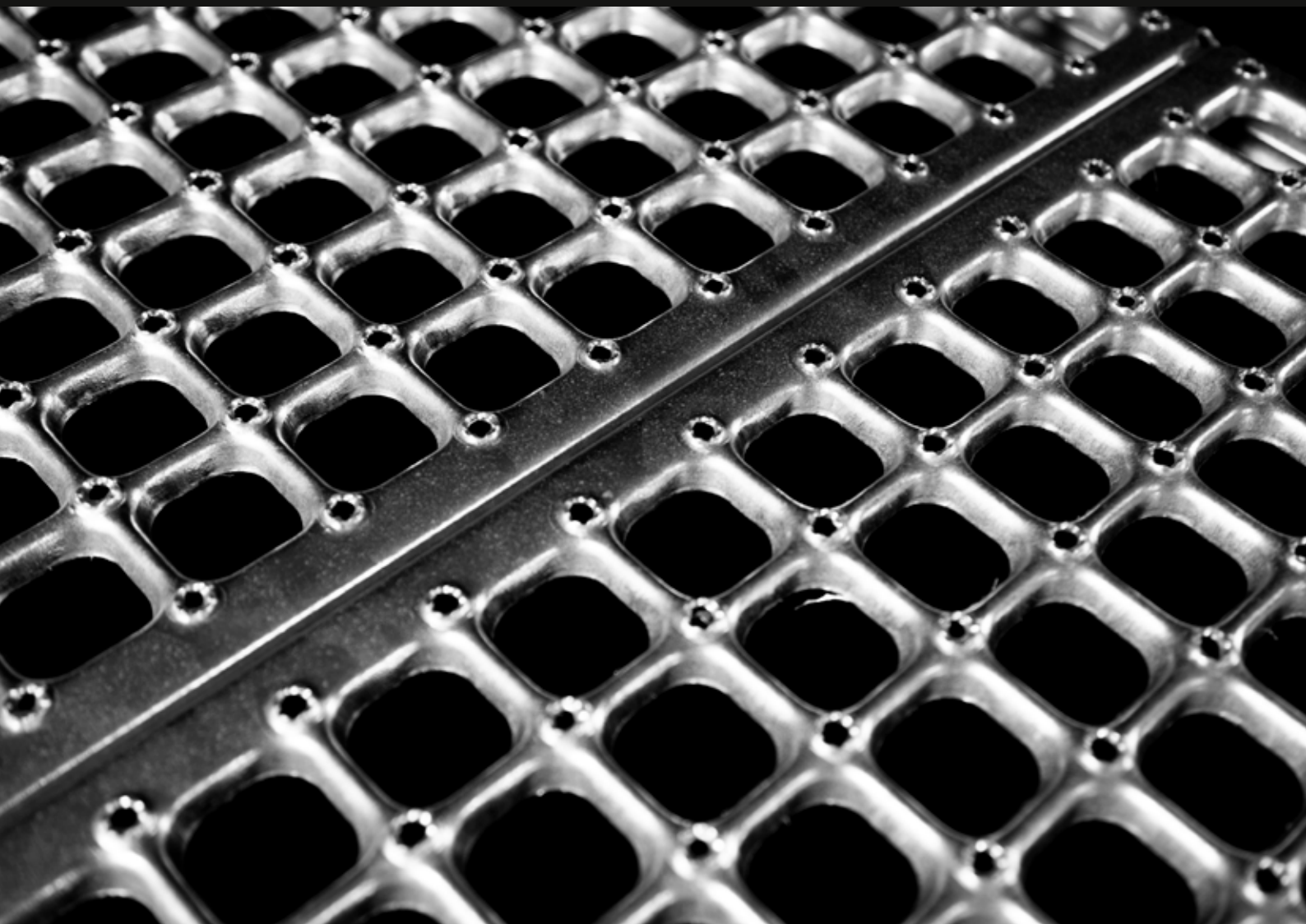

CUBE®

Next-generation gratings



PcP

Engineering Safety™

Safety is at the very heart of our products, solutions and through everything we do. Our drive is to enable our customers - no matter your industry - to safely operate in their business environment, supported and surrounded by innovative PcP solutions. Our products and solutions are used in many different types of buildings, applications, and installations. They are often exposed to harsh influences in heavy cargo, chemicals, high frequency cleaning, and weather and wind. Therefore, our products must live up to a high level of safety. The advice we offer about the dimensioning, use and maintenance of the products ensures our customers the optimal and safe solution for their particular project.

We always strive to help professionals engineer safety into every project.
Dedicated to follow our brand promise: **Engineering Safety™**.



05 The new alternative

06 Benefits

08 Design and functionality

10 Bespoke solutions

13 Explore cases & applications

25 Standard product programme

33 Product brands

34 Explore other product patterns



Gratings reimagined

The PcP CUBE® gratings embrace design, quality and safety and can be applied in all the industries where mesh gratings are used today.



The new alternative to the traditional mesh grating

PcP has been in the gratings market for many decades, always offering traditional mesh gratings. In 2019, we decided to create a new, improved grating series that provides the same physical properties as the traditional mesh gratings but with a completely new and more appealing design.

The new CUBE® grating series combines the strength in mesh gratings with high slip-resistance and low weight, so you can apply it for any project where the traditional mesh gratings typically are used. The CUBE® gratings series offers to add properties mesh gratings do not have.

Due to the clean look and the high strength to weight ratio, many engineers and architects specify the CUBE® gratings for various projects where safety, design and cleanability are criteria.

No matter the industry or application, you can easily replace traditional mesh gratings with CUBE® gratings.

CUBE gratings are very suitable for a range of applications, i.e. the industries industrial construction, building as well as for food and beverage, as follows:

- ✓ Platforms and open flooring
- ✓ Walkways
- ✓ Stair treads and landings
- ✓ Balustrade infills
- ✓ Balcony infills
- ✓ Façade covering
- ✓ Ceiling covering

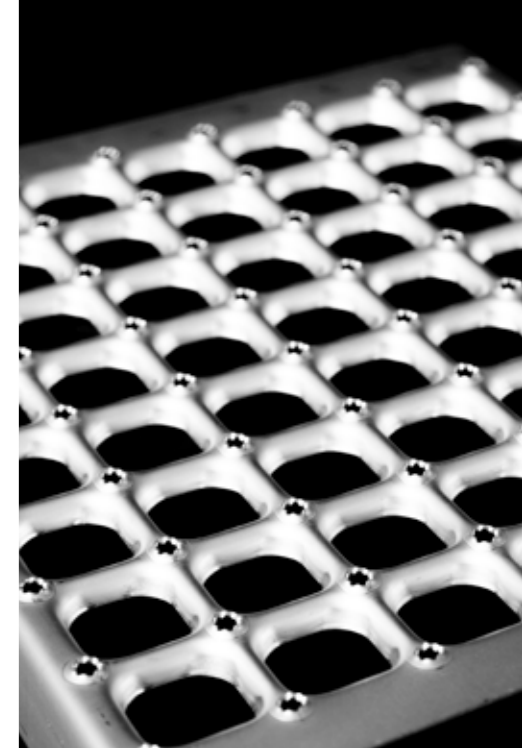



Benefits

Meet the future of gratings

PcP CUBE® gratings embrace design, quality and safety and can be applied in all the industries where mesh gratings are used today. CUBE® gratings combine lightweight and high strength and are an ideal cost-efficient solution for the construction industry and food & beverage industry where gratings and stair treads are required.

Exceptionally competitive

CUBE® gratings are a perfect alternative and more competitive on price than you can imagine. For many years, mesh gratings have been used for projects in the building- and industry sectors for walkways, access platforms and stairs and numerous other applications. CUBE® gratings and treads are tested according to European standards allowing you to apply it as a better alternative to the traditional mesh grating.

Simplistic design and functionality

You can apply CUBE® gratings for applications everywhere where design and load requirements are strict. The simplistic yet stylish design combined with high strength is a unique state-of-the-art product where no other grating type delivers these benefits in just one product.



Enhanced slip resistance

The slip resistance offered by the CUBE® is tested in accordance with BS 7976-2 and with DIN 51130.



Unique design

Designed by PcP the CUBE® is the latest innovation, a modern alternative to the traditional mesh grating, offering a unique and modern design.



High strength & low weight

The CUBE® grating has the optimal balance between weight and strength, making it a suitable and cost-efficient solution for all types of industrial applications.



Simple & quick installation

We designed the CUBE® gratings to be simple and easy to install - saving valuable time and enabling quick commissioning



Easy to clean

In food and beverage industries where hygiene is essential, the stainless steel CUBE® grating is suitable and easy to clean.



EN ISO 14122

CUBE® gratings comply with the European standard EN ISO 14122 for loading and BS 4592 Part 0: 2006 + A1:2012.



Design and functionality

Limitless possibilities

CUBE Gratings, planks and treads are very suitable for applications such as stairs, platforms and walkways i.e. building, construction & food and pharma industries.

CUBE® steel and stainless steel gratings and treads are the new alternatives for industrial building and construction. The CUBE® is a punch hole grating with a cold-formed design that offers a very high strength compared to the weight ratio. Therefore, it is a suitable alternative to the traditional mesh grating for projects, i.e. building and construction as well as food & pharma.

CUBE® steel gratings, panels and stair treads comply with the European Industrial standard EN ISO 14122-2 for a concentrated load of min. 1.5 kN on 200x200 mm and to BS 4592 Part 0: 2006 +A1: 2012. CUBE® Stainless steel hygienic gratings are ideal for the food, beverage and pharma industries. The unique shape of the CUBE® allows for easier cleaning and maintenance, supporting and promoting hygiene. CUBE® gratings, treads and panels are available in stainless steel AISI 304 and AISI 316.

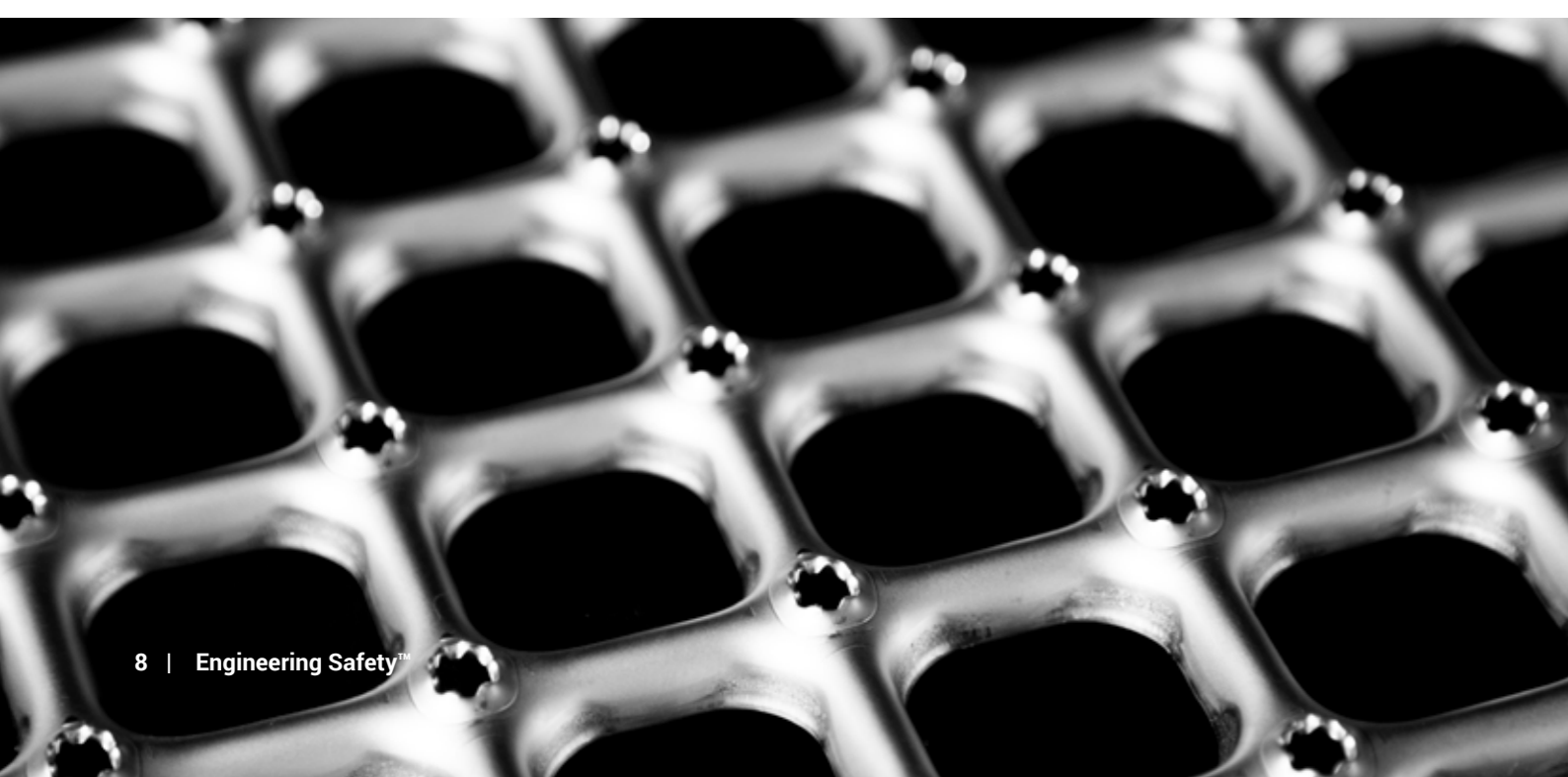

Multiple options

Three product types



Planks

We supply planks in stock to help you build your grating.

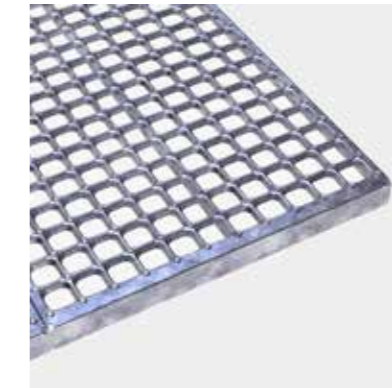

Plank gratings

We offer standard fabricated gratings and customised solutions.



Stair treads

We supply standard stair treads, and customisable tread planks and endplates.

Four design options

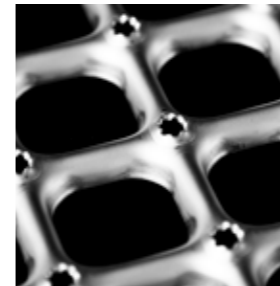

Oyster

Choose the Oyster option for enhanced slip resistance.

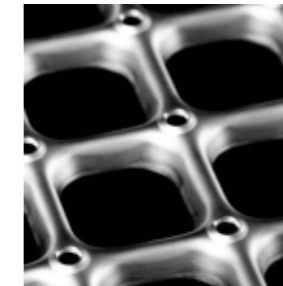

Round

Choose the Round option for slip resistance and a more comfortable surface.

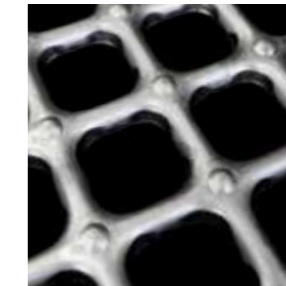

Dimple

Choose the Dimple option for a more even surface.



Plain

Choose the Plain surface for architectural solutions - on demand.

Four material grades



Steel 240YP



AISI 304

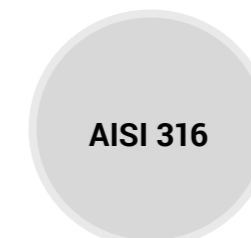

AISI 316

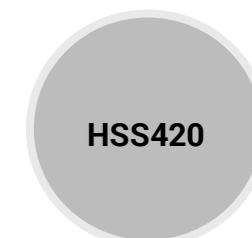

HSS420



Bespoke Solutions

How we can help to design your next project

From your first request to design, manufacturing, and delivery, PcP strives to meet your project expectations in every way possible. At PcP, we believe successful customised projects consists of committed collaboration combined with years of experience.

No matter the industry or application, CUBE® is an improved alternative to mesh gratings. It provides you with the benefit of high safety, combined with a unique design at affordable prices. Since the beginning of PcP in 1927, we have helped customers design and delivered bespoke solutions of very high quality. Over the years, PcP has built up an excellent production capability, vast knowledge and broad experience in what it takes to make a good, safe and economically optimal solution for a wide range of applications.

Trusted partnership

We work with each client to understand their needs and develop customised solutions to meet each project criteria. Our experienced team is ready to take you through the challenging task from design and development to manufacturing and on-time delivery. In close collaboration, we help you define which minimum requirements your customised solution should meet. To design your solution, we only need a construction drawing of your application. When entering into a project partnership with PcP, you can expect to receive support for the following project elements:

- ✓ Static calculations
- ✓ The optimal layout of pcP products in the construction for the most economical solution
- ✓ Physical testing of the solution if necessary
- ✓ 2D drawing material on the finished solution
- ✓ Approval of drawings at the customer premises
- ✓ Production
- ✓ Delivery

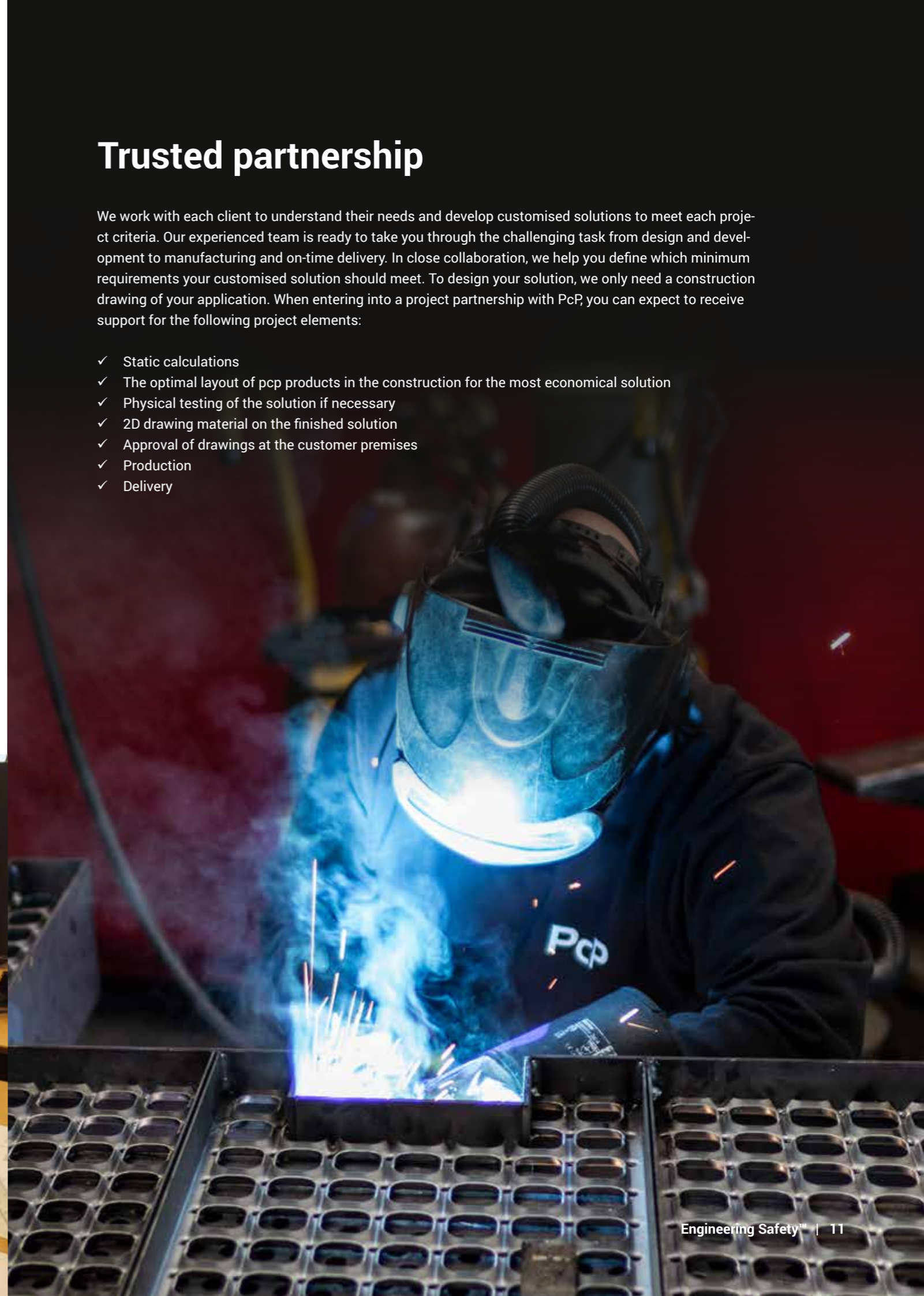
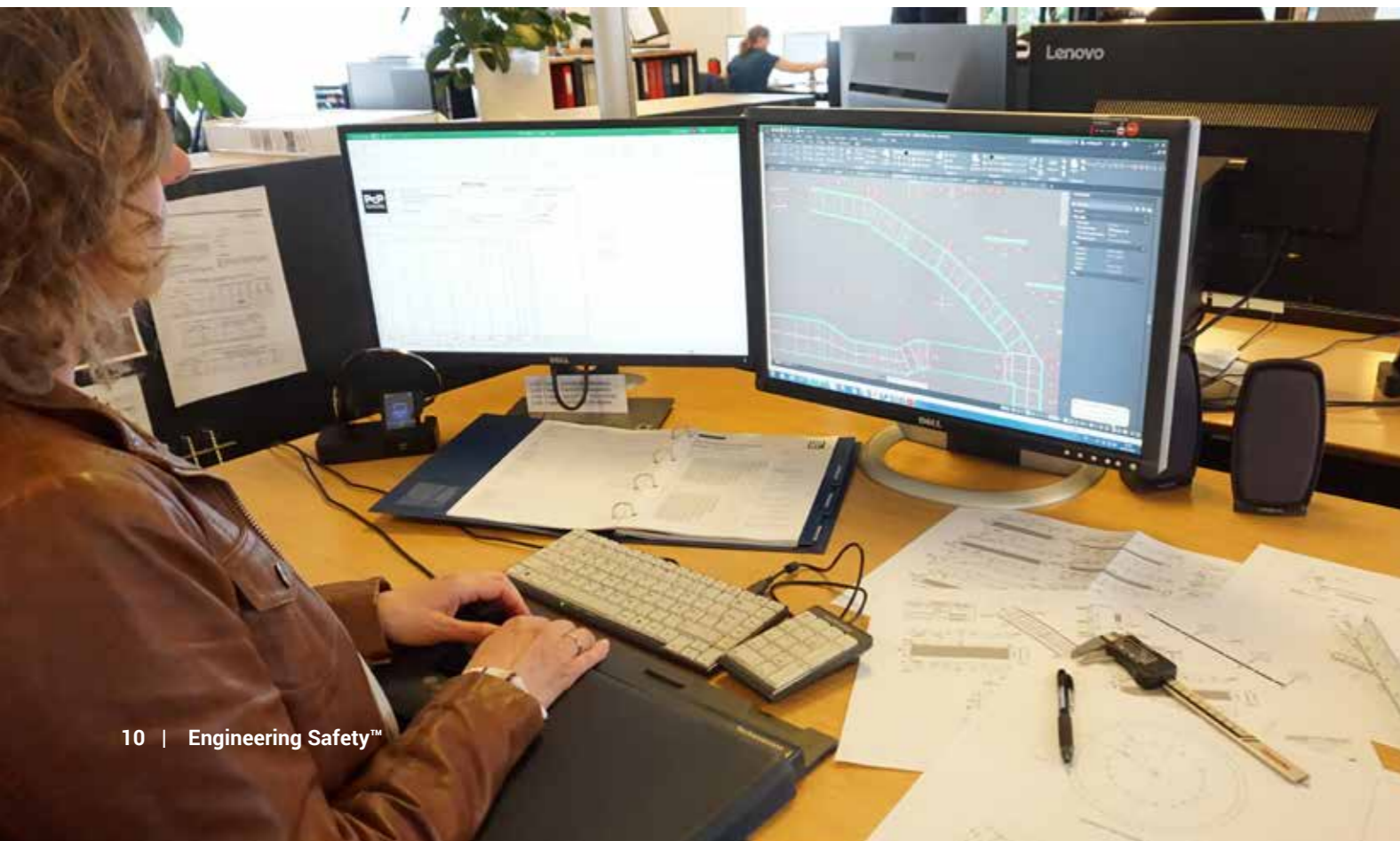



CUBE®

Explore our cases and applications

Pioneering safety across industries
and applications



Facade & ceiling coverings

Adored by engineers. Loved by architects.

The series of CUBE® gratings not only finds utility in practical safety solutions. The geometric qualities of the CUBE® series are an ideal companion to contemporary architecture and can be used to make ceilings, facades, and walls stand out. In close cooperation with design studios, architects and engineers, we develop recognisable, visual solutions that fuse form with function.

Architectural or functional coverings? The choice is yours.

CUBE® gratings offer an excellent air flow combined with a modern design; the gratings are suitable for modern facade and ceiling coverings on a building or large constructions, such as a bridge or a roof. You can combine CUBE® facade and ceiling solutions with any other material such as glass, brick or wood to create a visually aesthetic look. PcP specialises in producing customised solutions to suit all architectural and technical requirements. We have a significant number of stock products in the CUBE® series, ready for immediate delivery. But if your project has unique requirements, our flexible production allows for quick manufacturing and low cost of your next project.

Benefits when using CUBE® in ceiling or facade coverings



Light penetration

CUBE® gratings provide excellent light and air penetration - the perfect choice for facades and ceiling coverings.



Modern & functional design

With it's unique design, you can apply CUBE® gratings for a modern look on ceiling and facade coverings

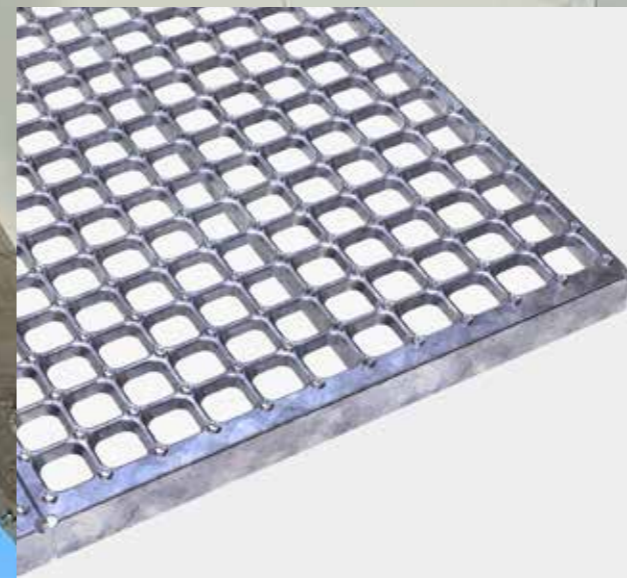

Relevant product

CUBE Steel 240 YP

CUBE® gratings are generally recommended in most constructions and industries where high air- or liquid flow are required.



Access walkways

Steel flooring solutions for industrial and public safety

CUBE® gratings are an optimal alternative to the traditional mesh gratings, and you can apply them for open steel flooring and access walkways in all industries without compromising safety or quality. CUBE® gratings offer optimal safety and strength and can easily replace the traditional mesh gratings for maintenance platforms, public walkways, emergency access, specialised or restricted access, i.e. areas with a specific design criterion. We have designed CUBE® steel flooring solutions to ensure the highest safety for the users.

Maximum safety on industrial maintenance platforms

We offer a wide selection of steel, stainless steel gratings and treads for industrial maintenance access platforms. With an excellent slip resistance, strength-to-weight ratio and high load capacity, CUBE® gratings are a safe and robust choice for industrial maintenance access and work platforms.

Standard or custom. The choice is yours.

We have a significant number of stock products in the CUBE® series, ready for immediate delivery. But if your project has unique requirements, our flexible production allows for quick manufacturing and low cost of your next project.

Benefits when using CUBE® in walkways and platforms



High strength. Low Weight

The CUBE® grating has the optimal balance between weight and strength, making it a suitable and cost-efficient solution for all types of industrial applications



Enhanced slip resistance

The slip resistance offered by the CUBE® complies with BS 7976-2 and with DIN 51130.

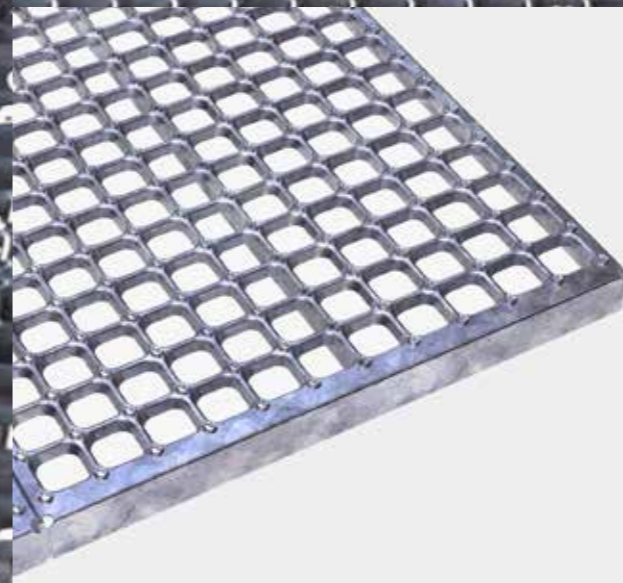
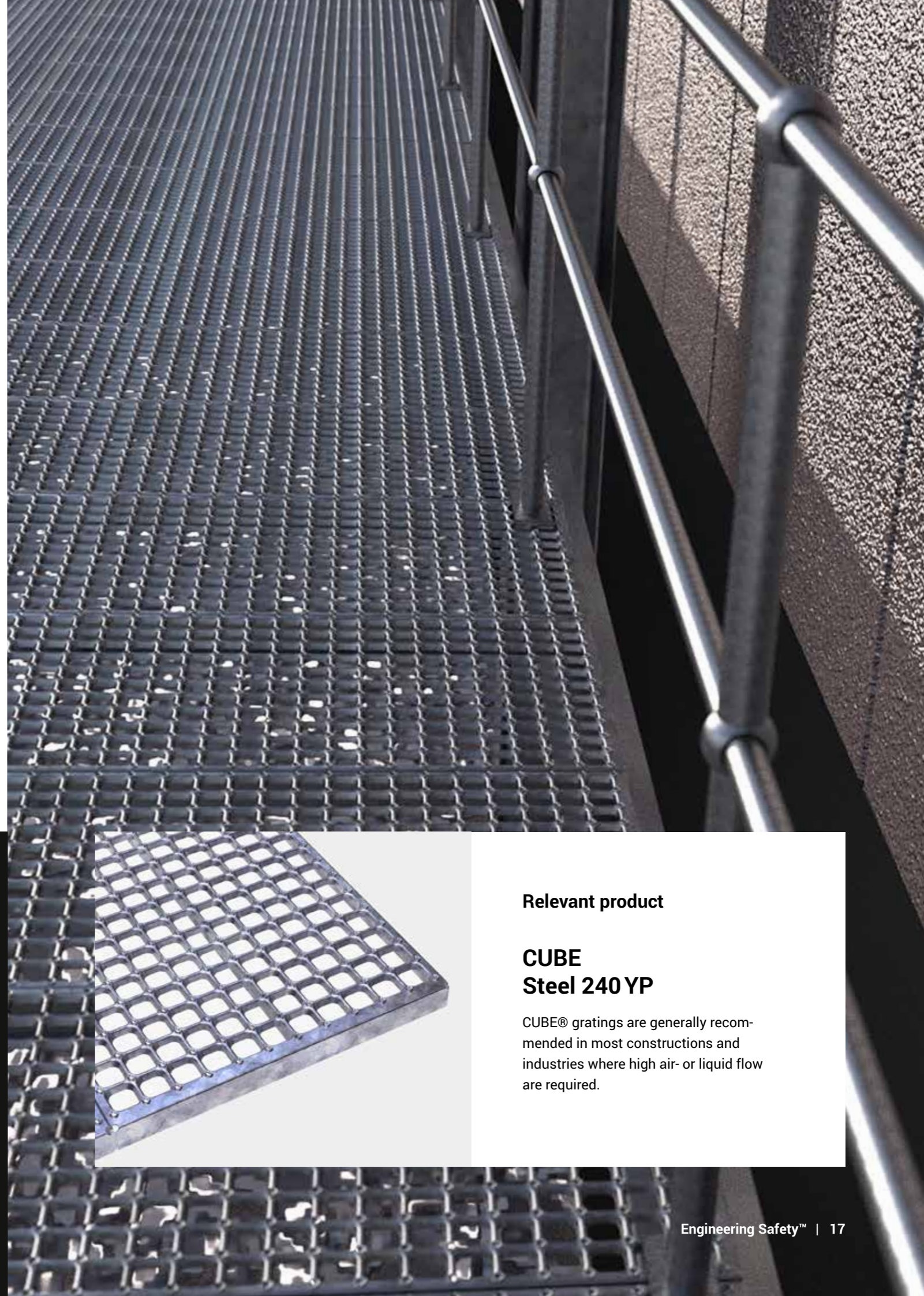

Relevant product

CUBE Steel 240 YP

CUBE® gratings are generally recommended in most constructions and industries where high air- or liquid flow are required.

Air BP

The Air BP fuel station project is based on a collaboration involving the Swedish partners Totech as project lead and Fremek. They installed the entire construction that includes PcP's solution to provide a safe platform.

This project PcP's solution includes CUBE® steel gratings and treads for a modern design and ladder systems for easy access to the fuel tanks. Fremek and Totech chose PcP's solution to install a new fuel station for Air BP's - one of the world's largest aviation suppliers.

The solution

PcP provided standard CUBE® gratings and treads for the maintenance platform. Fire escape ladders and safety handrails were provided for easy access to the platform. PCP CUBE® gratings and treads benefit slip-resistance, lightweight but strong and fitted perfectly into the existing construction from the ground to roof. Fremek installed the platform, and the workers made cut-outs on-site to make space for the fuel tanks. Additionally, PcP provided escape ladders to mount on to the fuel tanks. In case of fire incidents, workers can rapidly escape from the accident.

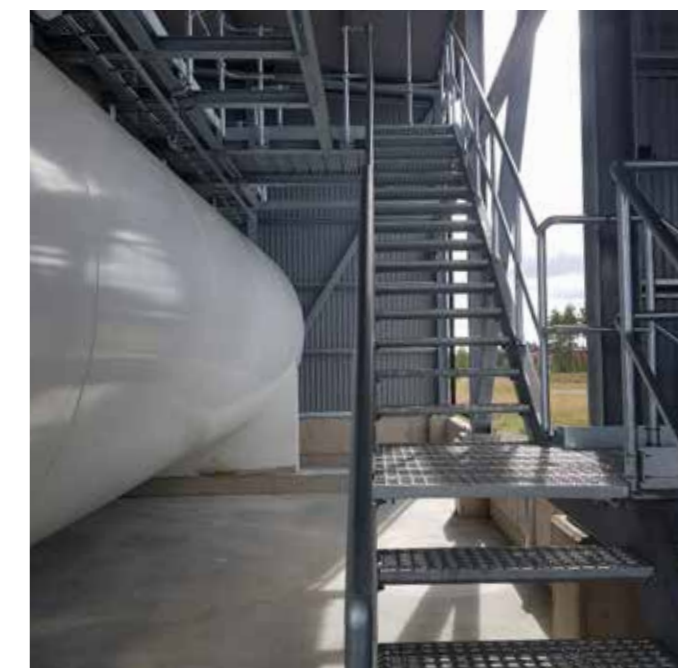

Benefits from using CUBE® in the solution



Slip-resistant platform

The risk for accidents and falls is significantly minimized.



Easy and quick to install

With CUBE gratings and treads in standard sizes, it was quick to install the platform and stairs.



Easy maintenance

Today, it's easier and safer to check fuel and make tests



Safe work environment

Maintenance workers feel safer during the job.



Heathrow Park

CUBE® gratings applied for 3,260 m² steel flooring for Heathrow Park access walkway

Heathrow Park is an industrial estate situated close to Heathrow Airport, UK. The construction project involved different collaboration partners – a UK steelwork and installation company and the main contractor, operating as crucial stakeholders in the Heathrow Park project. The steelwork company contacted PcP on behalf of the main contractor, looking for a cost-efficient steel maintenance roof walkway to access roof equipment.

The solution

PcP proposed the new CUBE® steel grating for Heathrow Park flooring as it could be designed to suit the spans required at a competitive price. However, and more importantly, CUBE® steel gratings proved a viable proposition to the client due to the product's low weight compared to other gratings. The delivery time also met the strict site requirements. For the project, PcP manufactured CUBE® gratings over six weeks using robotic welding on both day and night shifts to complete the project schedule. PcP experts delivered tailor-made CUBE® gratings for the steel flooring, and the work included paying particular attention to details, accurate technical drawings, and providing all the necessary product certification and datasheets.

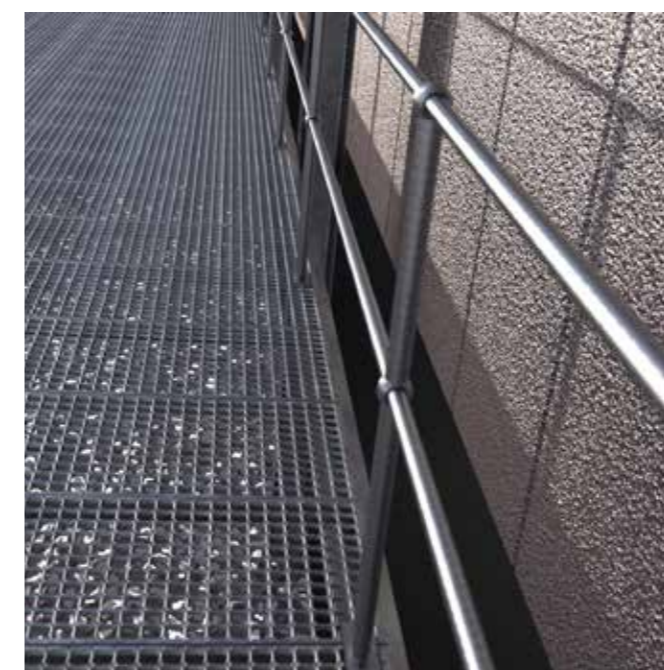
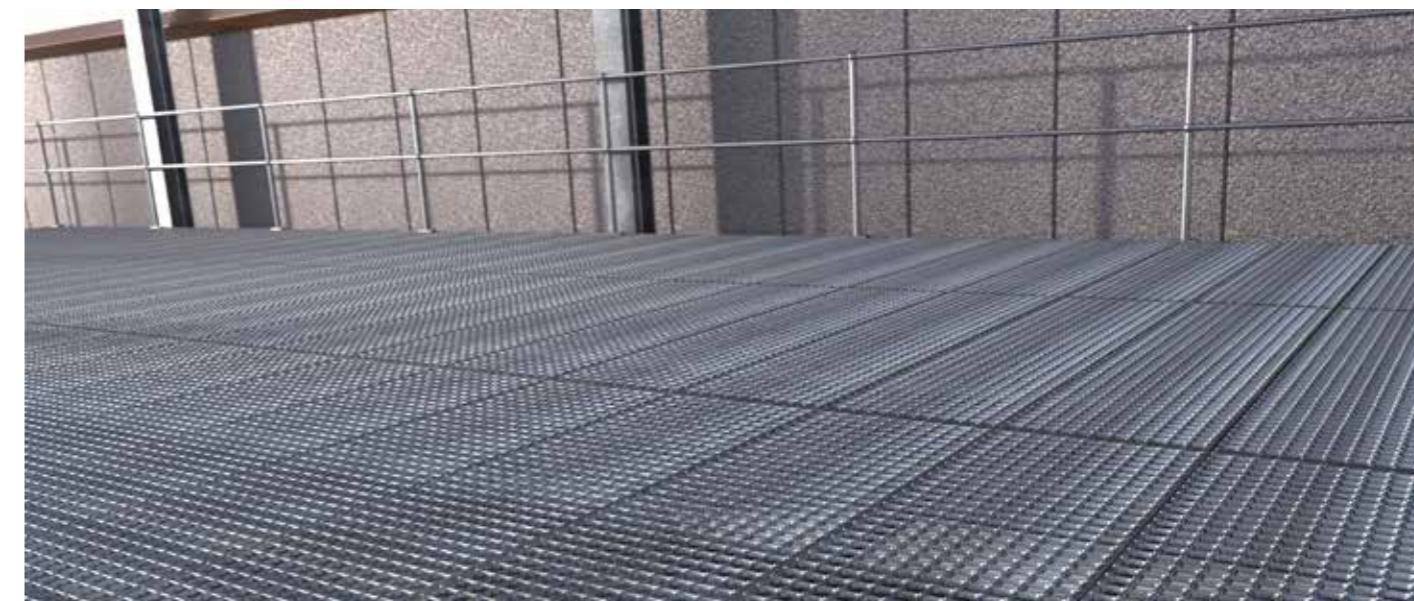

Benefits from using CUBE® in the solution

- ✓ **Cost-effective**
Most economical solution with excellent high-quality finish
- ✓ **Tailor-made**
Product supplied fit for purpose

- ✓ **Strength**
Better strength-to-weight ratio than the twisted bar that originally was considered
- ✓ **Full support**
Access to after-sales support including relevant datasheet and certification



Hising Bridge

Architectural CUBE® ceiling adorn the 440 metres long Hising Bridge.

CUBE® gratings provide a unique design and decorate the 1000 m2 ceiling below the new Hising Bridge of Gothenburg. The Hising Bridge is to become the new landmark of Gothenburg. Spanning over the central part of Scandinavia's most significant commercial harbour, The Hising Bridge will replace the existing Göta River Bridge from 1939.

The solution

The project partners chose PCP to provide the complete solution: ceiling, stairs, walkways, and service platforms. The different applications involved close collaboration between the partners throughout design, development, test and delivery. The range of applications was a thorough process of designing, drawing and technical advice. The entire solution involved PCP products from OPTIMO, CUBE and Guardrail.

1000 m2 CUBE® gratings decorate the ceiling below the bridge with a multifunctional purpose combining design and functionality. The unique design is simplistic and efficient and provides excellent light penetration at night.



Benefits from using CUBE® in the solution



Light penetration

The design of the CUBE® gratings allow for excellent lighting at night.



Unique design

CUBE® gratings decorate the bridge with an architectural look and feel.



Safe maintenance

Designed to ensure a safe environment for maintenance.



Durable

Access walkway, platform and stairs are designed to meet the high safety criteria for the project.





Product programme

We offer standard gratings and treads for customised solutions or prefabricated planks and gratings for further processing.



Planks and gratings

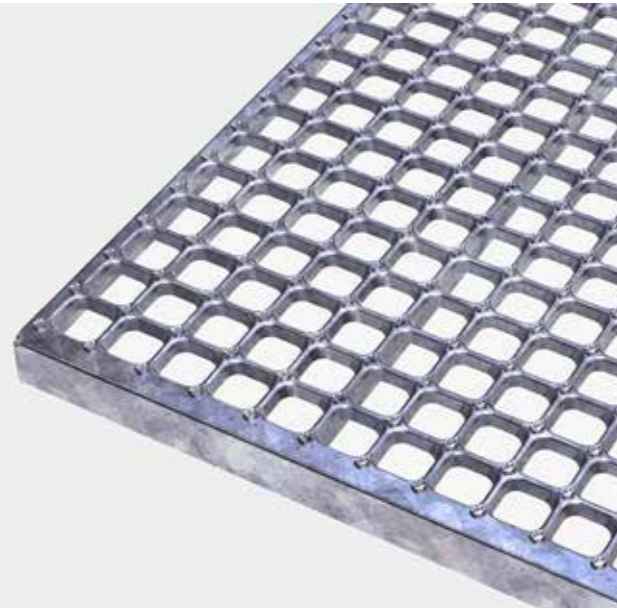

We offer customised grating solutions or prefabricated planks and gratings for further processing.

Plank specifications

Plank width (Pw)	200	240	333	415	500
Total height (Ht)	42	42	42	42	42
Material thickness	2	2	2	2	2
no. of CUBES (Pw)	4	5	7	9	11
Weight per meter (steel)	3,5	3,90	5,0	6,0	7,90
Weight per m ² (steel)	19,3	18	17,1	16,3	16,90
Weight per m ² (galvanised)	21,2	20,0	18,8	17,9	18,50
Weight per meter (stainless steel)	3,5	3,90	5,0	6,0	7,90
Weight per m ² (stainless steel)	19,3	18	17,1	16,3	16,90
Max. span*	1400	1300	1150	**1000	**950
Length (Ls)	4000	4000	4000	4000	4000
Open area, min.	51%	53%	53%	54%	56%

measurements in mm / weight in kg
 *based on planks welded together
 ** incl. 1 reinforcement (30x3 mm) in span direction/length
 load capacity acc. to EN ISO 14122-2: 1,5 kN / 200 x 200 mm

Standard items

Item	Option	Length	Width	Height	Thickness	Steel 240YP	AISI 304
Plank grating	Oyster	600	1000	42	2	Standard	-
Plank grating	Oyster	800	1000	42	2	Standard	-
Plank grating	Oyster	1000	1000	42	2	Standard	-
Plank	Oyster	4000	200	42	2	Standard	Standard
Plank	Dimple	4000	200	42	2	-	Standard
Plank	Oyster	4000	240	42	2	Standard	-
Plank	Dimple	4000	333	42	2	-	Standard
Plank	Oyster	4000	333	42	2	Standard	Standard
Plank	Oyster	4000	415	42	2	Standard	-
Plank	Oyster	4000	500	42	2	Standard	-
Plank with bearing bars	Oyster	4000	500	42	2	Standard	-

Accessories

Fixing clip, upper part Ma44/CUBE

Fixing clip, lower part

Socket button head screw - M8x60

Socket button head screw - M8x80

Square nut - M8x6.5



Build your grating

How to make gratings with planks

Planks are cut to size and welded together. Then, edge bars are welded to close end profiles.

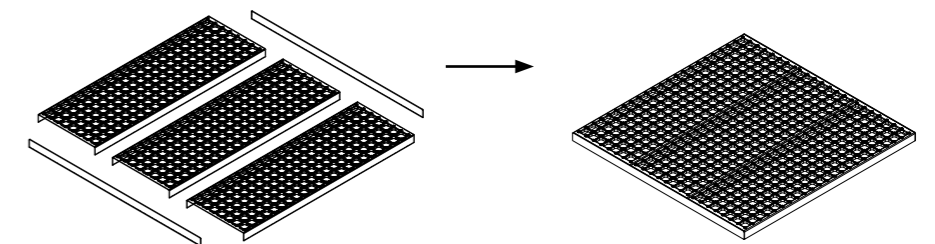

Length (L) equals span direction

Decreased plank width will increase the grating span.

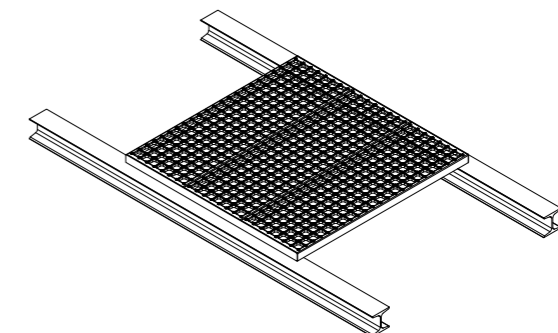



Stair treads



We offer standard stair treads, prefabricated tread planks and endplates for further processing, and bespoke tread solutions.

Treads specifications

Width (Pw)	240	270	305
Total height (Ht)	42	47	42
Material thickness (Mt)	2	2	2
K	120	150	180

	Length (L)	Weight		
	800	4,15	4,45	4,82
	900	4,62	4,95	5,36
	1000	5,09	5,45	5,90

measurements in mm / weight in kg

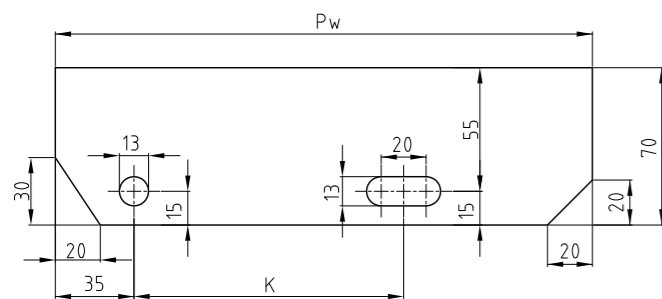

Standard items

Item	Option	Length	Width	Height	Thickness	Steel 240 YP	AISI 304
Tread	Oyster	800	240	42	2	Standard	Standard
Tread	Oyster	900	240	42	2	Standard	Standard
Tread	Oyster	1000	240	42	2	Standard	Standard
Tread	Oyster	1100	240	52	2	Standard	-
Tread	Oyster	1200	240	52	2	Standard	-
Tread	Oyster	600	240	42	2	Standard	-
Tread	Oyster	800	270	47	2	Standard	Standard
Tread	Oyster	900	270	47	2	Standard	Standard
Tread	Oyster	1000	270	47	2	Standard	Standard
Tread	Oyster	1100	270	52	2	Standard	-
Tread	Oyster	1100	270	52	2	Standard	-
Tread	Oyster	1200	270	52	2	Standard	-
Tread	Oyster	800	305	42	2	Standard	Standard
Tread	Oyster	900	305	42	2	Standard	Standard
Tread	Oyster	1000	305	42	2	Standard	Standard
Tread	Oyster	1100	305	57	2	Standard	-
Tread	Oyster	1200	305	57	2	Standard	-
Tread plank	Oyster	4000	240	42	2	Standard	-
Tread plank	Oyster	4000	270	42	2	Standard	-
Tread plank	Oyster	4000	305	42	2	Standard	-
End plate			240	70	2	Standard	-
End plate			270	70	2	Standard	-
End plate			305	70	2	Standard	-

Build your tread

How to make stair treads with planks

Cut the tread planks to fit the required size, and weld endplates on to each.

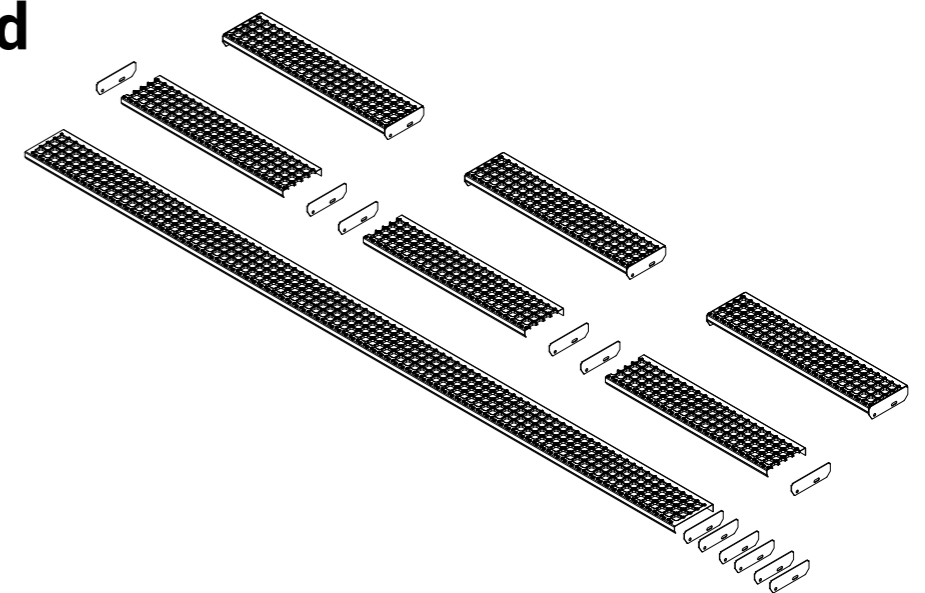



Technical information

To ensure safe handling and installation of our standard products, we provide all the relevant information. Besides, we offer the technical support and knowledge needed to optimise your application with a suitable and financial solution. We are always available to support you with technical advice and guidance - contact our experienced team if you need help to find precisely the solution that suits your needs.

On our website www.pcp-corp.com, you can find all documentation about the standard products such as:

- ✓ 3D and 2D drawings
- ✓ Product data sheets
- ✓ Cargo specifications
- ✓ Performance Declarations
- ✓ User manuals
- ✓ Examples of typical applications

CE
NO. 00175

PcP Corporation
Ydeevnedeklar
Certificate No. 0200-CPR

- Byggevarer type**
B-CUBE Oy trin - 2
- Byggevarer identifikation**
B-CUBE Oy trin er i huller og runde, savt lakkede, optrækshul og flange - svejset i DIN 24531. B-CUBE Standard dimensioner Længde fra 500 til 11. Højde fra 40 til 70 mm. Materiale tykkelse er
- Byggevarerens tilsigtede**
B-CUBE Oy trin er monteret i miljøer hvor der er et belastningskrav skal anvendes i områderne dimensioneringen, g i modstået fald kan P beskrive ydeevne
- Fabrikantens navn og**
PcP, Danmark, A/S
Sverigesvej 2-4
DK-7480 Vildbjerg
- Navn og adresse på de**
ikke relevant.
- System til evaluering**
2+
- Notificeret organ**
FORCE Certification
Park Allé 345
DK-2605 Brøndby

CUBE®
Plank grating C-CUBE Oyster
Stainless steel

Punched hole mesh gratings C-CUBE® Oyster has a high strength-to-weight ratio which means that strength is maintained while weight is reduced. The greater the span, the lower is the weight - in relation to pressure-locked mesh gratings. C-CUBE® Oyster mesh gratings are recommended in industries where hygiene and high air- or liquid flow are required.

Specifications	30+ Low Slip Potential
PTV guidelines	104
Dry PTV average	70
Wet PTV average	70
Slip resistance	R13 + class "D" acc. to DIN 51130
Displacement space	V10 in accordance with DIN 51130
Free area	50.56 %
Upward grip holes	standard dia 6.5
Downward drainage holes	36x36mm
C-Cube	43.5 x 43.5mm
Ball proof	35 mm in accordance with EN ISO 14122:2

Suitable application areas
Access Walkways & Maintenance Platforms
Landings

PcP Corporation
Sverigesvej 2-4

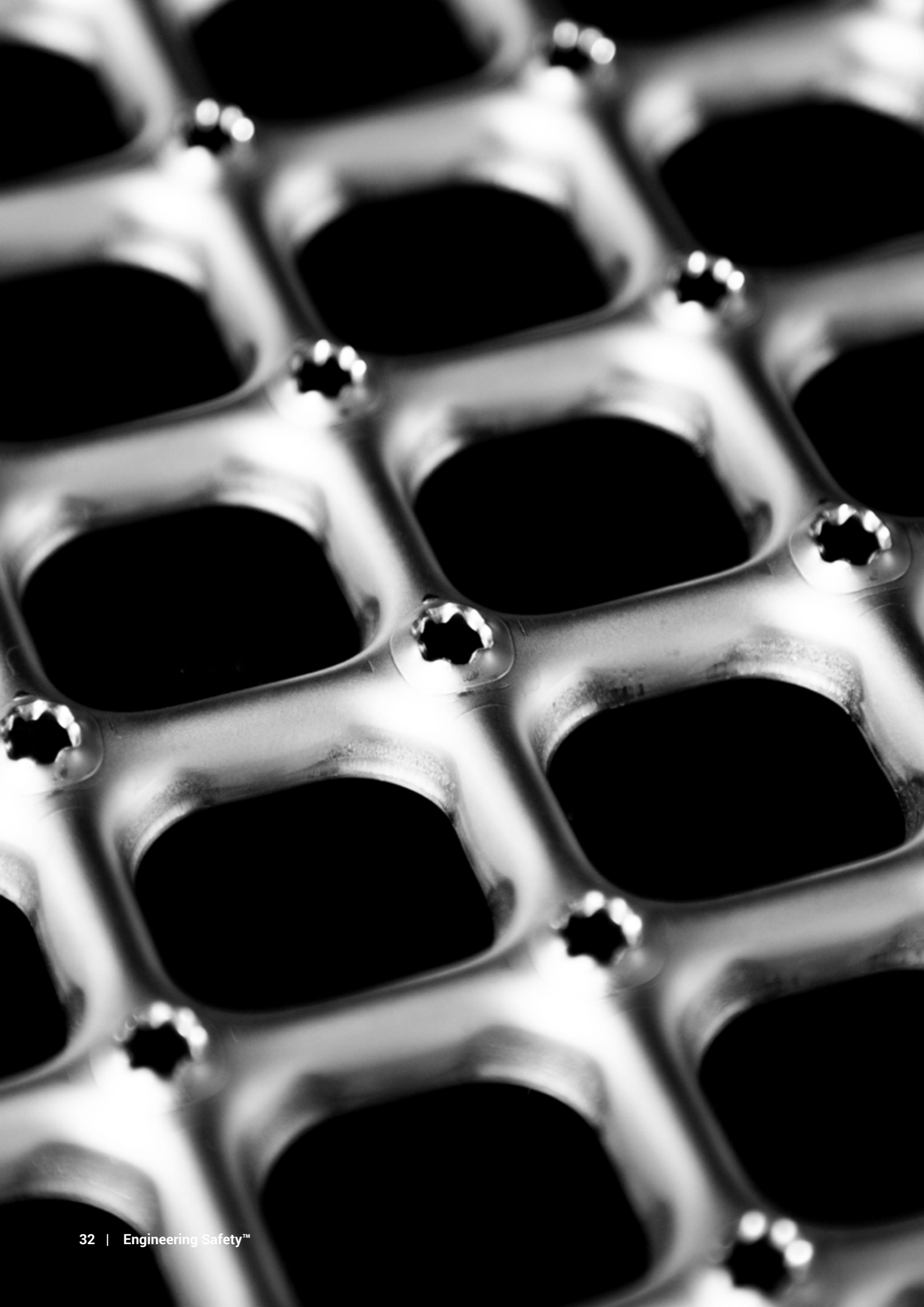

Product brands

We strive to deliver value through our diverse product brands and exceed expectations across all industries and applications. Explore our most popular brands below - gratings, treads, planks and much more. Available in standard or custom sizes.

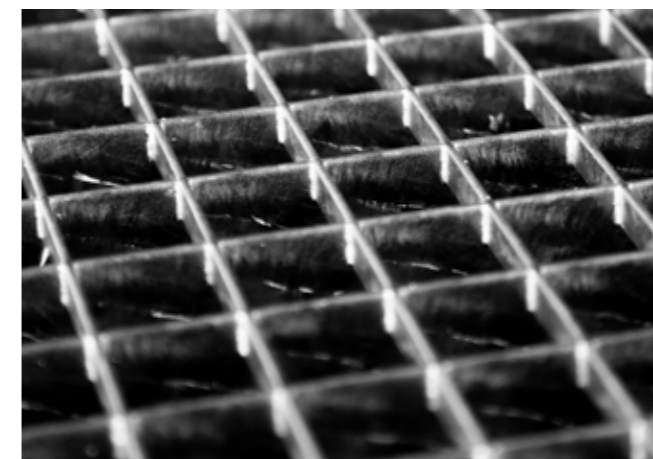
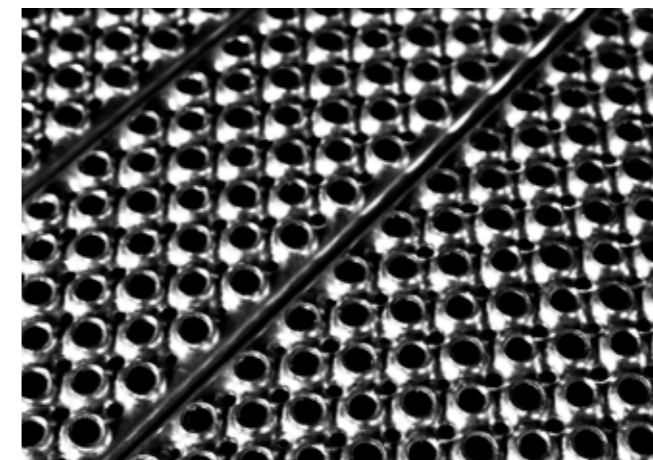
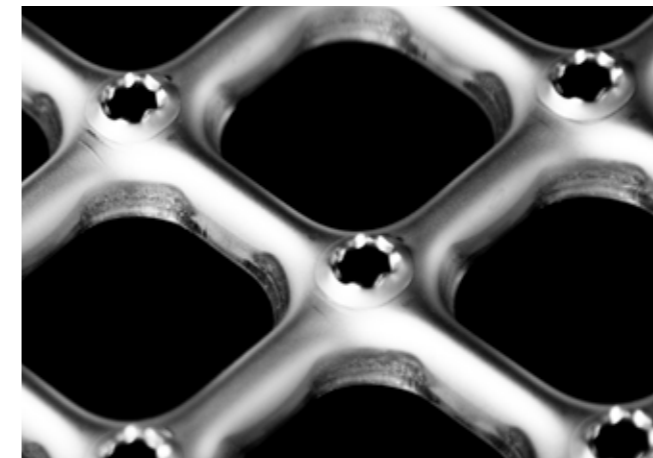

Explore other product patterns

Safety gratings and treads for applications across industries

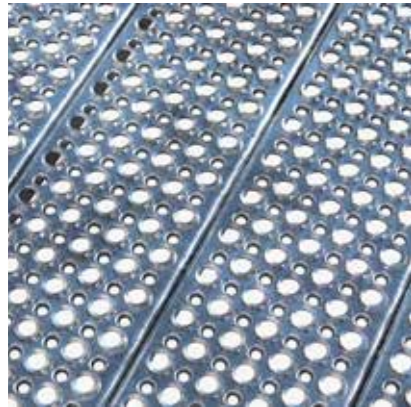

OPTIMO O2
steel | stainless steel | aluminium
max slip resistance
pattern: dia. 9/5 mm

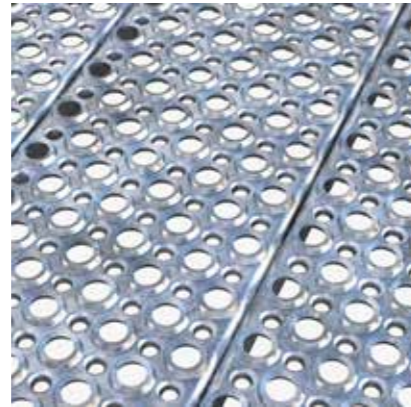

OPTIMO O3
steel | stainless steel | aluminium
max slip resistance
pattern: dia. 14/8,5 mm

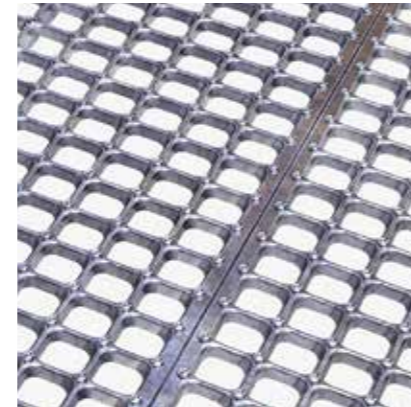

CUBE Oyster
steel | stainless steel
max slip resistance
pattern: serrated dia 6,5/34x34 mm

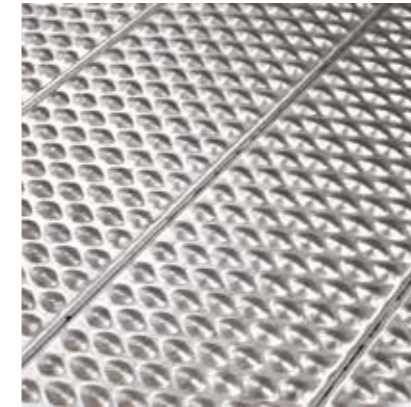

OPTIMO E
steel | stainless steel
heel proof | closed surface

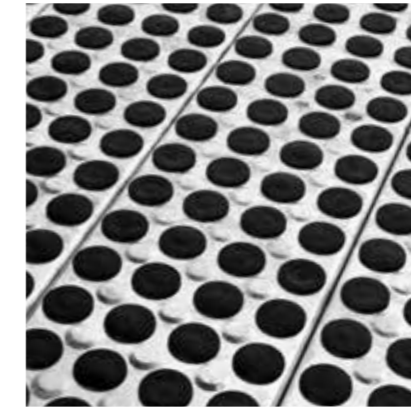

OPTIMO G
steel
heel proof | closed surface
rubber plugs available

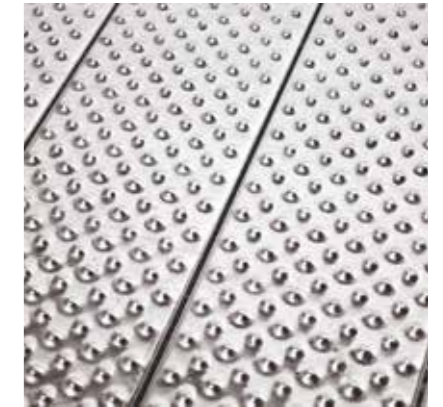

OPTIMO D
steel | stainless steel | aluminium
heel proof | closed surface

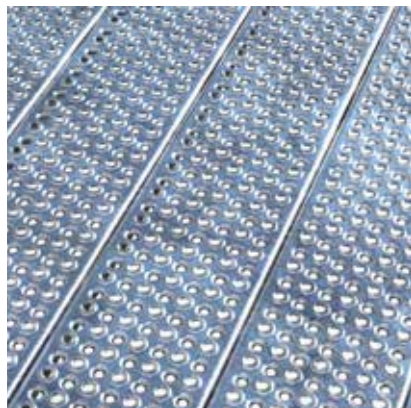

OPTIMO O5
steel
slip resistant | heel proof
pattern: dia. 5/5 mm



OPTIMO LHD
steel
fire protection | slip resistant
pattern: dia. 6/6 mm



OPTIMO STAR
steel | stainless steel | aluminium
increased open area | slip resistant
pattern: serrated dia. 21/21 mm

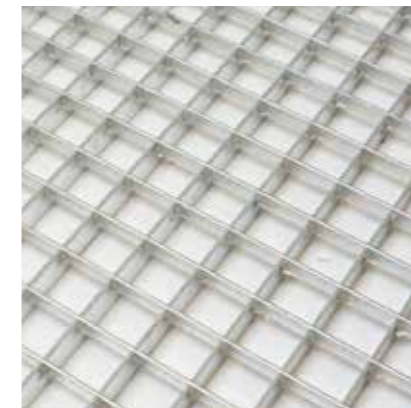

MESH
steel | stainless steel | aluminium | corten
countless mesh combinations available
optional slip resistance properties



OPTIMO US
steel | stainless steel | aluminium
increased open area | slip resistant
pattern: serrated 48x14/48x14 mm

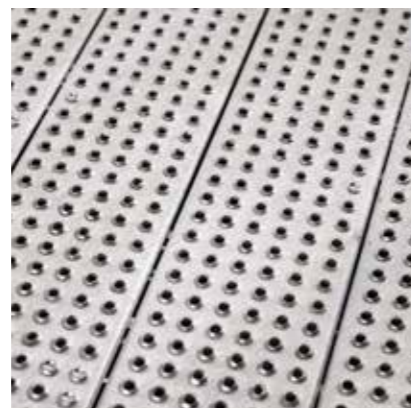

OPTIMO SPS
steel | stainless steel | aluminium
heel proof | slip resistant
pattern: dia. 5 mm



OPTIMO K
steel
decreased open area | slip resistant
pattern: dia. 14/9 mm

Explore our products at www.pcp.corp.com

PcP's product range covers a vast range of gratings, treads and planks in various materials, finishes and patterns. PcP designs, develops and manufactures gratings to provide safety no matter the industry or application. Explore our brands; CUBE®, OPTIMO®, MESH™ at www.pcp-corp.com.

Engineering Safety™

Safety is at the very heart of our products and through everything we do. Our drive is to enable our customers - no matter their industry - to safely operate in their business routine, supported and surrounded by innovative PcP solutions.

DENMARK

PcP. Danmark A/S
Sverigesvej 2-4
7480 vildbjerg
+45 97 13 1200
salg@pcp-corp.dk

SWEDEN

PcP. Sverige AB
J A Gahms gata 6
421 31 Västra Frölunda
+46 31 53 59 60
forsaljning@pcp-corp.se

NORWAY

PcP. Norge AS
Kanalvegen 8
4033 Stavanger
+47 51 95 00 50
salg@pcp-corp.no

GERMANY

PcP. Deutschland GmbH
Duisbergstraße 13
58339 Breckerfeld
+49 2338 91 81 10
verkauf@pcp-corp.de

BELGIUM

S.A. PcP. Belgium N.V.
Rue de Remouchamps 34D
4140 Sprimont
+32 4360 94 50
vente@pcp-corp.be

NETHERLANDS

PcP. Nederland B.V.
Havendijk 21
4731 TA Oudenbosch
+31 165315300
info@pcp-corp.nl

UNITED KINGDOM

PcP. Gratings Ltd.
Enterprise Drive, Four Ashes
WV10 7DF Wolverhampton
+44 1902 791 792
sales@pcp-corp.co.uk